

FALCON 800G2

AUTOMATIC HARDNESS TESTER | METALLURGICAL MICROSCOPE

MICRO/MACRO VICKERS, KNOOP & BRINELL



FALCON 800G2 A | B | C

Cutting edge technology, and beyond...

The new FALCON 800G2 series micro | macro Vickers, Knoop and Brinell hardness testing systems provide the next level of hardness testing experience. The FALCON 800G2 series stands for state-of-the-art laboratory equipment of the latest generation. The 800G2 combines hardness testing and metallurgical microscopy flawlessly based on a brand new optical system with full color camera's providing reproduceable and reliable results regardless of the hardness scale selected.

The FALCON 800G2 series contains an 8 position turret including dual indenter positions, objectives, positioning laser and an advanced surface touch probe. The turret is protected by the sensitive CDR system (Collision Detection & Retraction) avoiding any damage to the turret or parts to be tested.

The iSMART™ quick change adapter can hold and identify fixed anvils, manual stages or the brand new iSMART™ series of wireless motorized CNC X-Y stages with a 0.001mm positioning accuracy. Maximum flexibility at any moment in the machines lifetime.

The wide test load range of 0.1gf – 62.5kgf confirms latest innovations on force control and providing ultimately precise measuring results. IMPRESSIONS™ 4 software creates maximum user comfort due to nearly unlimited functions controlled by advanced interfaces.





Select your required version & test force range...

0.1gf	10gf	2kgf	FALCON 800G2 A B C - OPTION 2	62.5kgf
0.1gf	10gf	10kgf	FALCON 800G2 A B C - OPTION 3	62.5kgf
0.1gf	10gf	31.25kgf	FALCON 800G2 A B C - OPTION 4	62.5kgf
0.1gf	10gf		FALCON 800G2 A B C - OPTION 5	62.5kgf
0.1gf	200gf		FALCON 800G2 A B C - OPTION 6	62.5kgf

Upgrade now, later, at any moment, during order or online!

EXTENSION A	0.1gf - 1gf	EXTENSION B	1gf - 10gf	EXTENSION C	10gf - 200gf
EXTENSION D	2kgf - 10kgf	EXTENSION E	10kgf - 31.25kgf	EXTENSION F	31.25kgf - 62.5kgf

HARDNESS SCALES

	VICKERS also HVD (HVT)	0.1gf - 60kgf
	KNOOP	1gf - 5kgf
	BRINELL also HBD (HBT)	1kgf - 62.5kgf
	ROCKWELL (OPTIONAL)	3kgf - 60kgf



HIGHLIGHTS

- 1 Multi Load Cell, Closed Loop force application system, error <0.25%
- 2 3 configurations for Z-axis displacement available, models A, B & C
- 3 8 position, silent, ultra fast positioning turret, 2 indenter positions, 4 infinite LWD objectives, touch probe, laser positioning system
- 4 Ultra-fast auto focus system
- 5 Infinite high performance optical system with top quality objectives
- 6 CNC motorized diaphragm/ iris and CNC motorized polarizer/optimizer
- 7 Metallurgical microscope functionality with METALLOSCOPE™ software
- 8 Collision detection & retraction (CDR) system avoids turret damage
- 9 18 megapixel full, 4K, full color integrated camera system
- 10 18 megapixel stage overview camera, variable field of view
- 11 White TTL power LED, Dual bank power LED stage illumination
- 12 iSMART™ docking station for CNC X-Y motorized or manual stage solutions
- 13 Integrated active vibration and climate control system
- 14 Integrated system controller, i7 processor, Dual MSSD Raid system storage, or external pc
- 15 Industrial 27" touchscreen, option for 2 x 24" screens or projector
- 16 Top-class replaceable body parts, shock proof ABS covers



METALLURGY

Grain size	DIN EN ISO 643, ASTM E112
Volume fraction	ISO 942, ASTM E562
Coating thickness	DIN EN ISO 1463

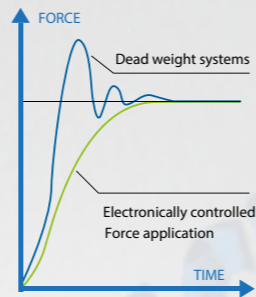

Load cell, closed loop, force feedback system

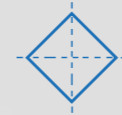

VICKERS

DIN EN ISO 6507, ASTM E-92, ASTM E-384

HV0.0001 - HV0.0010 (step HV0.00005)

HV0.001 - HV0.010 (step HV0.001)

HV0.010	HV0.015	HV0.020	HV0.025	HV0.050
HV0.1	HV0.2	HV0.3	HV0.5	HV1
HV2	HV2.5	HV3	HV4	HV5
HV10	HV20	HV25	HV30	HV40
HV50	HV60			



KNOOP

DIN EN ISO 4545, ASTM E-92, ASTM E-384

HK0.001	HK0.002	HK0.003	HK0.004	HK0.005
HK0.006	HK0.007	HK0.008	HK0.009	HK0.010
HK0.015	HK0.020	HK0.025	HK0.050	HK0.1
HK0.2	HK0.3	HK0.5	HK1	HK2
HK5				



BRINELL

DIN EN ISO 6506, ASTM E-10

HBW1/1	HBW1/1.25	HBW1/2.5	HBW1/5	HBW1/10
HBW1/30	HBW2.5/6.25	HBW2.5/7.8125	HBW2.5/15.625	HBW2.5/31.25
HBW2.5/62.5	HBW5/25	HBW 5/31.25	HBW 5/62.5	



ROCKWELL

EN-ISO 6508, ASTM E-18, JIS Z 2245

Regular Rockwell scales; Pre Load 10kgf, Main Load 60kgf

A F H L

Superficial Rockwell scales; Pre Load 3kgf, Main Load 15kgf | 30kgf | 45kgf

15N 30N 45N 15T 30T 45T 15W 30W 45W 15X 30X 45X



CONVERSIONS

DIN EN ISO 18265, ASTM E140

SUPPORTED METHODS & SCALES

FALCON 800G2

CONFIGURATIONS

Ultimate configuration freedom....

Unique in the world of hardness testing, is a hardness tester that can have 5-axis and even 7-axis controlled if you include the CNC motorized Diaphragm and CNC Motorized polarizer system.

The comprehensive software IMPRESSIONS 4™ provides unmatched control over all mechanics and optics.

The possibilities of version C are unique if it comes to working height operation. No other hardness system in the world offers such a versatile way of working. While for the users that prefer a fixed working height, the ball screw Z-axis slide gives the comfort to test on a fixed working height.

INNOVATEST has put relentless efforts in designing a top class high end machine, with unmatched parts quality, optics and flexible way of working.

HEAD



VERSION A

4-axis system, descending/elevated test head

Version A of the FALCON 800 has a newly developed motorized (Z-axis) descending / elevated test head.

The indents are not applied by the test head but with a separate force actuator within the test head providing the vertical displacement while force/load is applied over special force transducers. This dual displacement system guarantees high speed and absolute precision on test force control.

On the base of the frame you can find the fixed iSMART quick change adapter that allows the installation of any type of anvils, manual or digital X-Y stages or a selection of CNC motorized X-Y stages (see also page 12).

The descending/elevated test head accommodates a variable indent and viewing position / working height.

VERSION B

VERSION B

4-axis system, fixed test head, ball screw stage z-axis

Version B of the FALCON 800 has a traditional fixed test head position. The indents are not applied by the test head but with a separate force actuator within the test head providing the vertical displacement while force/load is applied over special force transducers. This dual displacement system guarantees absolute precision on test force control.

Height adjustment (z-axis) of the working stage/anvil takes place over a high precision vertical CNC motorized slide. Mounted on top of the slide you can find the iSMART quick change adapter that allows the installation of any type of anvils, manual or digital X-Y stages or a selection of CNC motorized X-Y stages as it also provides the adjustment for auto focus.

The fixed test head accommodates a fixed indent and viewing position.

STAGE



VERSION C

5-axis system, descending / elevated test head & ball screw stage z-axis

Version C of the FALCON 800 represents the state-of-the-art, ergonomic, "best of both worlds". This top end model has both the newly developed motorized (Z-axis) descending / elevated test head of model A but also the high precision Z-axis slide with iSMART adapter of version B.

The indents are not applied by the test head but with a separate force actuator within the test head that provides the vertical displacement while force/load is applied over special force transducers. This dual displacement system guarantees absolute precision on test force control.

This advanced up to 5-axis CNC controlled positioning system, allows users to create an excellent and ergonomic working height position for either sitting or standing positions, regardless of the dimensions of the workpiece.

5 axis machine control providing ultimate workpiece positioning and versatility in machine operation. Prepared for future upgraded c machine functionality.

HEAD



STAGE



8-POSITION TURRET

ULTRA FAST MODULAR TURRET

The newly designed turret of the FALCON 800G2 provides 8 positions for Indenters, objectives, laser and touch probe. The system is prepared for additional tooling options as well, while the infinite corrected objectives can have ring lights installed that with Brinell Artificial Intelligence functionality gives the best possible Brinell results, far better than any other system ever designed.

The high precision force actuators installed on the turret hold any 3mm shaft indenter, Micro Vickers, Vickers, Knoop and Brinell.

Positioned under 30degr. providing better overview on the workspace and stage, the newly designed very fast rotation mechanism is free from any sound, position controlled by a precise rotary encoder and position blocked by a motorized mechanical actuator.

Above the turret, installed in the test head, is the linear force application mechanism. This high resolution fine mechanical system provides the test forces applied by the indenter actuator.

Test forces are therefore independently applied and are so perfectly controlled that the FALCON 800G2 can be optionally supplied as Class A standardizing machine.

LOW FORCE INDENTER POSITION

Can hold Micro Vickers, Vickers, Knoop and Brinell indenters up to 5mm

LASER POSITIONING SYSTEM

Provides a marker that helps to align parts, components or specimen in the correct testing position.

SPRING LOADED TOUCH PROBE

Provides the ultra-precise position of the to be tested surface, which speeds up indentation and autofocusing process, additional to a position reading system taken by the indenter in the indentation process.

OBJECTIVES

Infinite, color corrected, High Quality objectives, with long working distance, meeting or exceeding DIN EN ISO 6507-1/2 : 2018

OBJECTIVES WITH RING LED LIGHTS

The objectives 2,5X, 5X, 10X can be equipped with a special ring LED lights that provide the best possible Brinell indent images, and can be further enhanced by the Artificial Intelligence AI software module.

CDR

The turret itself and the individual installed optics and indenters are protected by the INNOVATEST developed CDR (Collision Detection & test head retraction) system.

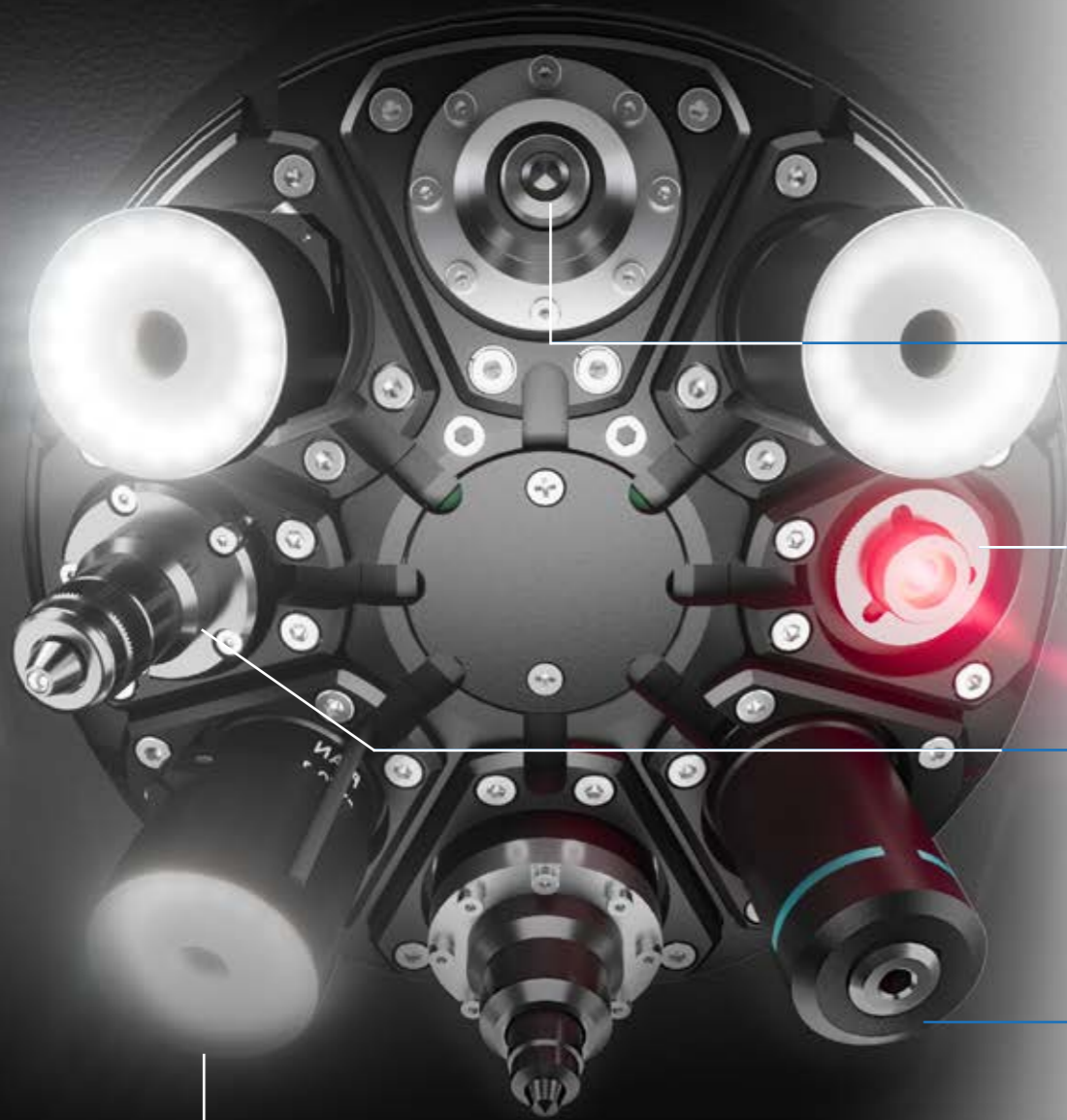

DOCKING STATION

The FALCON 800G2 has a iSMART™ docking station for the quick mounting of workpiece platforms. The docking station allows a wide variety of test tables, anvils, manual XY stages and the new wireless iSMART™ motorized CNC X-Y stages to dock within seconds. In this way, the user can create the most ideal circumstances for his particular workpiece.

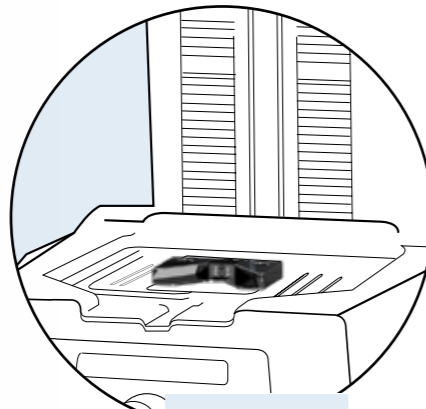

iSMART™
DOCKING STATION

The docking station is a new INNOVATEST standard. It can be found on an increasing number of hardness testers. This means your fixtures, stages, anvils and even the wireless iSMART™ motorized CNC X-Y stage are interchangeable between the various machines in your possession. No need to duplicate expensive tooling for different machines.

The iSMART™ docking station provides communication identification and power supply to various mounted accessories.

iSMART™ technology offers unlimited configuration freedom and safety for your tester. Creating a hardness testing system that can be configured to any requirements with standard or bespoke options, fitting a wide range of stage accessories and fixtures. Automatic Stage recognition provides overload protection and prevents damage to accessories.

iSMART™ MANUAL | DIGITAL X-Y STAGES *A variety of manual and digital stages are available from the accessories list.*

Manual iSMART™ stage
UN-XYSTAGE/120
Surface: 100 x 100mm
Travel: 25 x 25mm

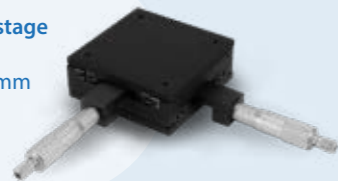

Digital micrometer*
IMP-DIGMIC
25 mm travel



Digital control unit*
BM-08-0059
50 mm travel



Digital control unit*
BM-08-0058
25 mm travel

Manual iSMART™ stage
BM-08-0057
Surface: 150 x 150mm
Travel: 50 x 50mm

**Can be used on a variety of manual stages, see page 31 (Stage/anvils)*

MOTORIZED CNC X-Y STAGES

The new wireless iSMART™ motorized CNC X-Y stages provide excellent specifications combined with maximum flexibility. This new technology allows you to purchase a standard machine to start with, add stages, change dimensions of motorized CNC stages according to new requirements later in the life of the tester and upgrade in just seconds!

WIRELESS iSMART™ STAGES



iSMART™ technology reduces possible down time on stage maintenance to seconds in case of calamities. While most automatic machines will be "out of service" if the stage is defective, a wireless iSMART™ stage can just be exchanged in seconds. No downtime!

There is a choice of 7 different type of iSMART™ stages (see table below) and if you need larger dimensions or different specifications for Custom Products, we can manufacture any possible stage to your requirements.

iSMART™ stages have onboard controllers. The EIS (electronic identification system) communicates with your hardness tester to create safety and assure no stage overload can take place.

The stages have pre-determined hole patterns on their surfaces. These patterns are in line with all INNOVATEST hardness testing stage accessories such as 1, 4, 6 or 12 position sample holders, vices and others.

AVAILABLE DIMENSIONS

Type	MA-XY7575S	MA-XY1212S	MA-XY2212S	MA-XY3412S
Travel mm	75x75	120x120	220x120	340x120
Surface mm	215x160	260x205	360x205	490x224
Max load kg	400	400	400	400

Consult with our sales department for other dimensions with short lead times.

TECHNOLOGY HIGHLIGHTS

- High speed positioning by motors and drivers for medical applications.
- Ball bearing spindles with overload protection clutches.
- Integrated ultra precise position reading electronics.
- Position accuracy 0.001mm, repeatability 0.0015mm.
- 4 different dimensions and travel options, see table above.
- Maximum load 400kg.
- Quick Change iSMART™ adapter, mount stage in seconds
- Wireless or wired connectivity.
- Replaceable, upgradeable, interchangeable.
- Matt black finish for maximum contrast with objective and overview camera's.

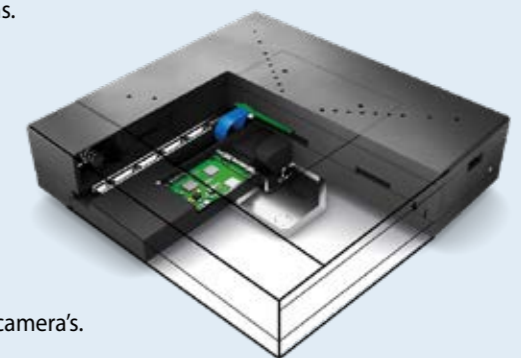

CONFIGURATION FREEDOM

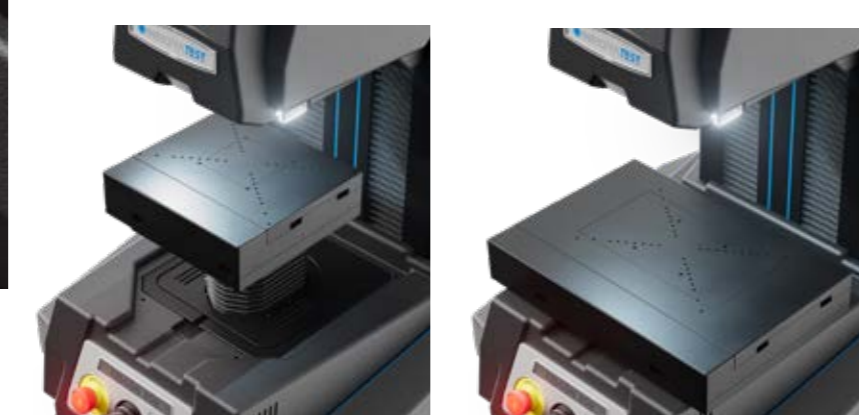

Most high-end hardness testing machines are built as an "as is" concept which means the automatic stage is an integral part of the tester. The configuration is final and determined. But not for the FALCON 800! The iSMART adapter and various stage and anvil solutions can be changed within a minute. They are even "hot swappable" which means no -power off- required.



If your budget initially does not allow an automatic stage, you can start with a manual stage. At any moment in time you can purchase any stage/anvil accessory and simply exchange all kinds of accessories according to need.

Your original purchase was a small automatic stage, and later you need a larger stage for a different job, simply replace the stage in less than 1 minute.

Besides this unique fast docking station technology, INNOVATEST CNC motorized stages can carry very large loads, for FALCON 800 A, B & C this is up to 400kg.

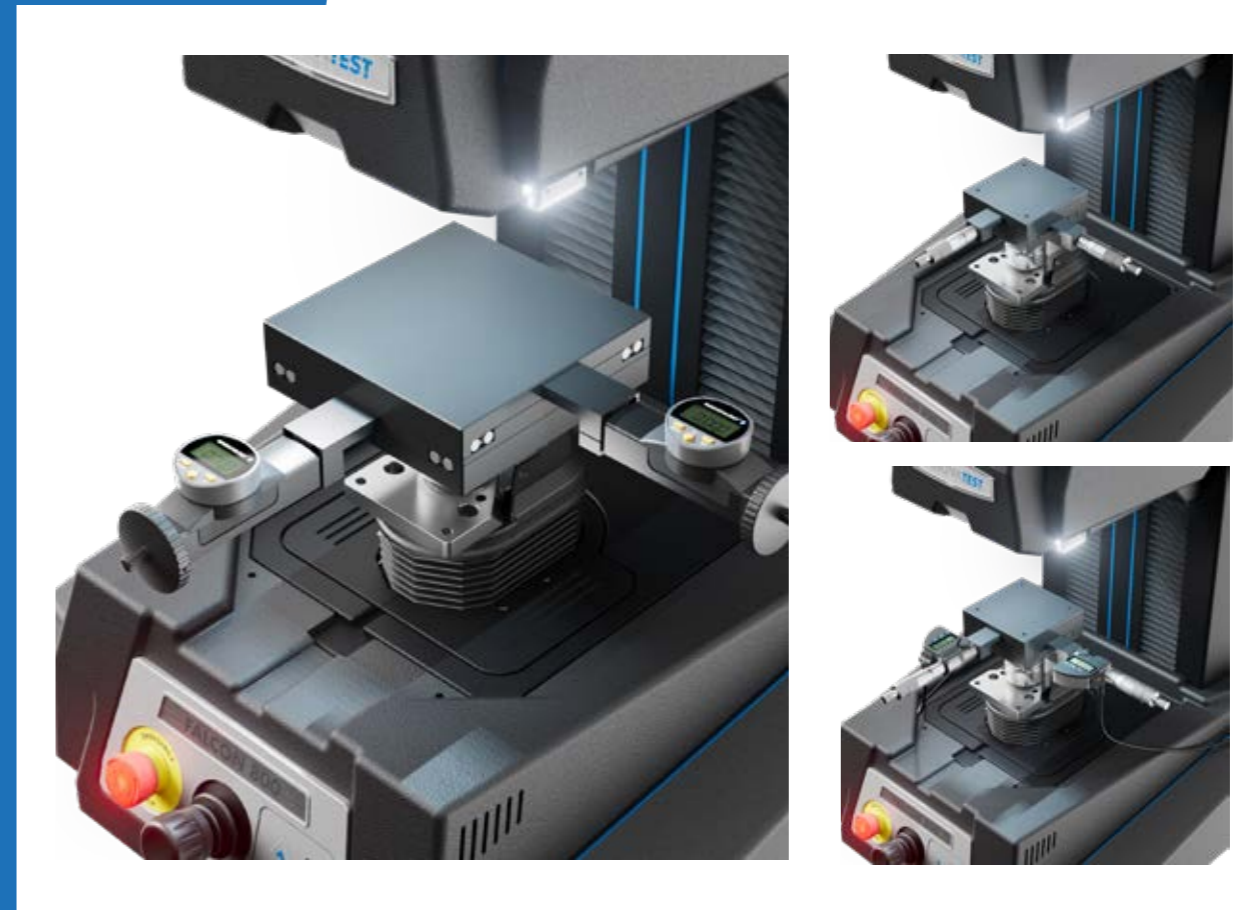

Controlling complexity...

Software to optimize user comfort with a wide range of standard functionality such as auto measurement, auto-focus, reporting, test program storage, and many more.

For the more advanced users, for whom the standard applications would not be sufficient, IMPRESSIONS™ 4 has an unmatched level of optional “apps” that can be installed as plugins, later, at any moment. During the purchase of your tester, decide on what you need at that moment. Widen your options at any moment by a simple e-mail and a few mouse clicks, to install optional functionality. As easy or simpler than installing an app on your mobile phone.

Obtain a software release ticket, and your tester has added functionality, regardless where it is located. A revolutionary system, taking care of all your needs.

In this way we keep the learning curve, the process to work efficiently with our software limited to the level of “need to have” and “need to know”. The proportion of installed and activated software never needs to be more than your requirements.

Unique to IMPRESSIONS™ 4 is a choice for screen size and position. Whether you wish your interface to be in landscape, all functionality is supported in both positions. For table top solutions like testers in laboratories, users often opt for landscape screen(s).

On the shopfloor the large landscape screens are often an unwanted component either requiring a table top or machine mounted bracket taking a lot of space and cables to deal with. IMPRESSIONS™ 4 leaves you the option to go for landscape or for portrait mode on a large selection of our machines.

For the FALCON 800G2, INNOVATEST recommends the 27” industrial quality landscape screen operated by both touch as well as mouse and keyboard. One screen is standard included with the hardness tester, optional is the Dual view function, these are 2 x 24” industrial quality landscape screens. New applications are added to IMPRESSIONS™ 4 on a regular basis; while INNOVATEST provides 10 years free updates, upgrades to more functionality or new additions can be purchased at any time.



On the higher end, IMPRESSIONS™ 4 connects flawlessly with quality control systems such as QDAS, exports files in CVS, XML or other formats and if your requirement is not standard, our team of engineers will efficiently find ways to handle your data properly. Bespoke solutions such as connectivity to robotic systems are standard solutions for INNOVATEST™.

POWERED BY IMPRESSIONS v4

Next gen workflow & tester control...



TIME REDUCING SOFTWARE SOLUTIONS...

1 PATTERN EDITOR

The IMPRESSIONS™ pattern editor allows the user to create any number of test patterns with a large number of variable settings. Create test patterns with great precision and freedom. Verify the settings in the preview mode. Drag & drop patterns from one test sample to another sample. Live vision technique over zoom overview camera, no image stitching required.

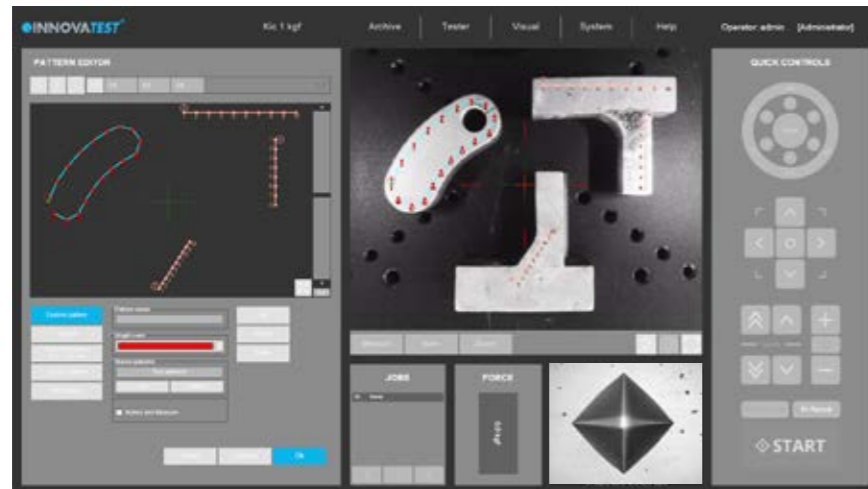

Combine different patterns and even different test forces in one program, and run them fully automatically. All test points can be identified individually or to customer specifications. The label is shown in the test result list and in the test results overview and in the results print out. An important function for sample analyses at the end of a test and in the future for review of previous tests.

2 CHD, SHD, NHD

How do you increase throughput in your lab? Make the most common testing design as easy to set up as possible to perform automatically and still adhere to the applicable standards. CHD/SHD/NHD testing can be started directly from the surface view or from the overview. Additional core points of hardness can be defined separately for NHD measurements.

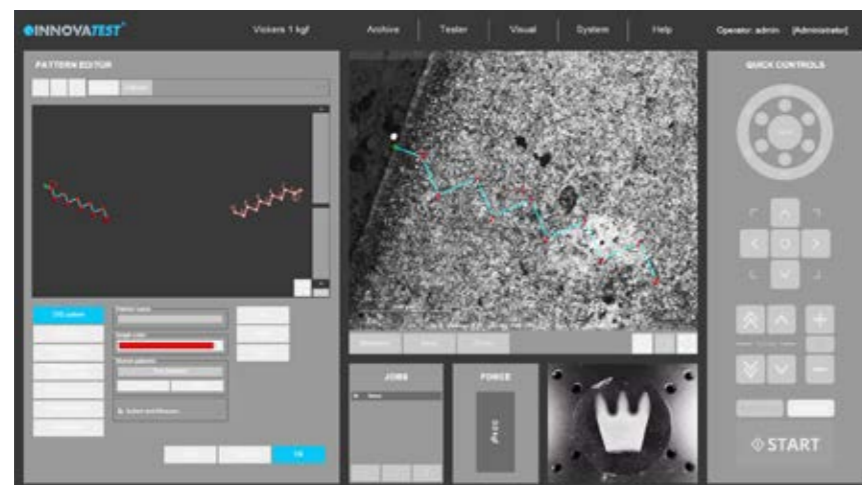

The distances of test points are automatically set to a minimum distance, following the standard, to assure correct testing is conducted. Time saving test mode "complete all indentations - then evaluate" and "auto-stop" to complete test series as soon as the lower hardness limit has been reached. Report Generator is enhanced with reporting features for this application.

3 WELD INSPECTION (ISO 9015)

This especially developed tool enables you to conduct hardness testing on welded parts or segments according to ISO standard. Setting up the pattern according to the requirements becomes "easy-to-do", due to pre-set test points in the different zones of the weld and automatic correlation between test points. The system will run a fully automatic test procedure and display and record the results accordingly. The Report Generator is enhanced with reporting features for this application.

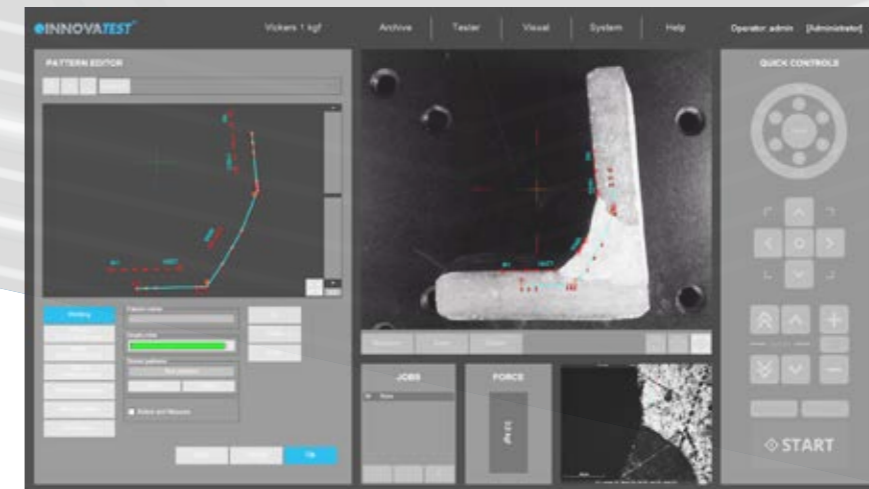

4 HARDNESS OF SCREW THREAD DECARBONIZED ZONE (ISO898-1)

A specialized software tool of IMPRESSIONS™ allows you to set up and conduct fully automatic testing as per ISO898-1 for screw thread measurement of (de)-carbonized part.

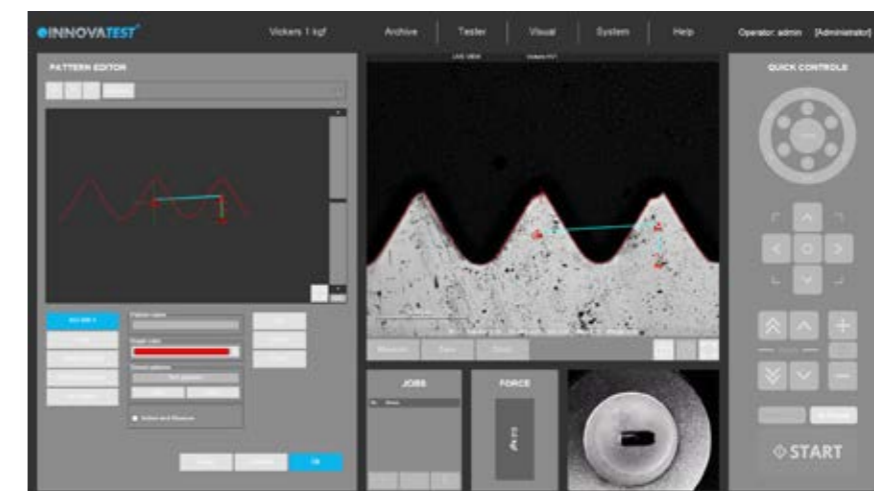

The Report Generator is enhanced with reporting features for this application.

5 EDGE DETECTION

Technology that automatically or at a mouse click recognizes the edge of your sample. This helps to determine and fix the desired starting position for CHD or other pattern testing jobs.

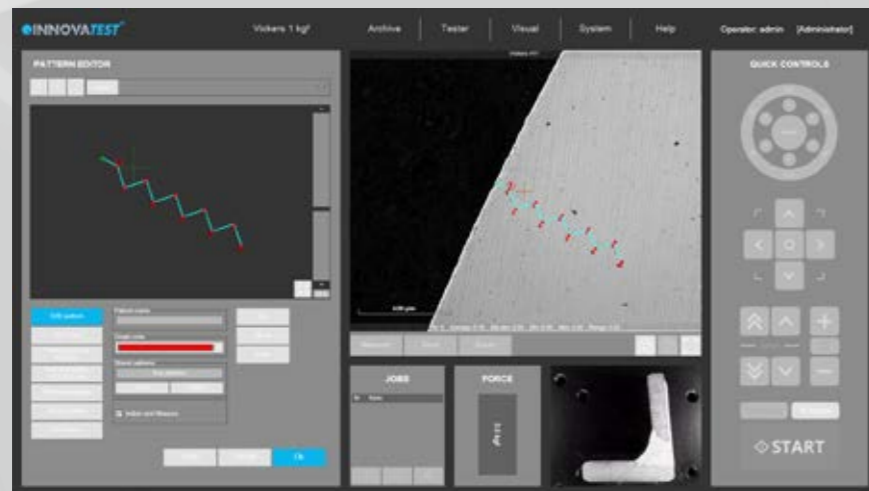

7 2D HARDNESS CHART

The application „Plane hardness chart“, is also referred to as Color Mapping happens to be the perfect tool for securing the detail of the effective hardness distribution over the total sample cross section of heat treated samples. An important feature in material exploration, weld testing or in damage analysis.

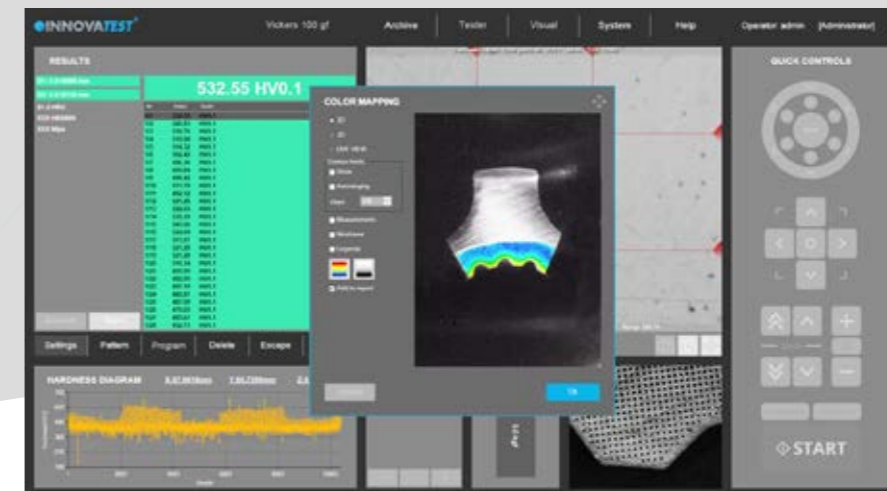

6 AUTOMATIC CONTOUR SCANNING

This application scans the entire outline (or partial) area of a sample. The function can be used with an objective by using the overview zoom camera for high speed scanning. The system scans the entire outline defined and stores all relevant data in the test program.

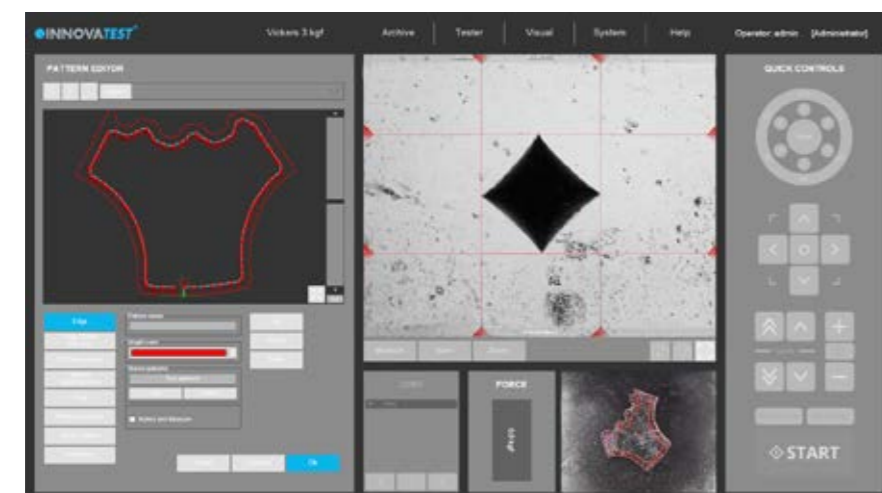

8 3D HARDNESS CHART

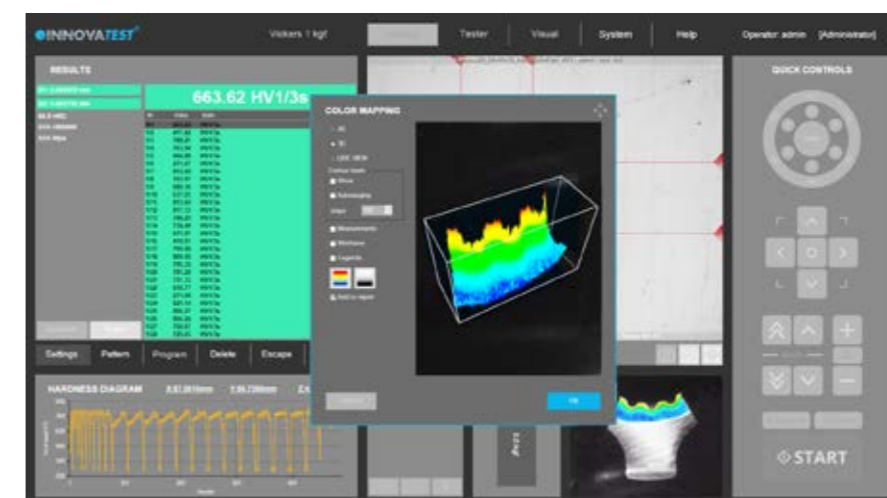

In addition to 2D graphic diagrams, the system can also automatically generate 3D diagrams. 2D and 3D hardness charts are included in one application.

Subsequently, a limitless number of test points can be inserted into the scanned image, or be set at selected distances (offset), relative to the edge. This advanced feature enables the hardness testing procedure to be performed. An excellent feature combined with 2D or 3D hardness mapping, also known as “plane hardness chart”.

9 Kic CRACK MEASUREMENT

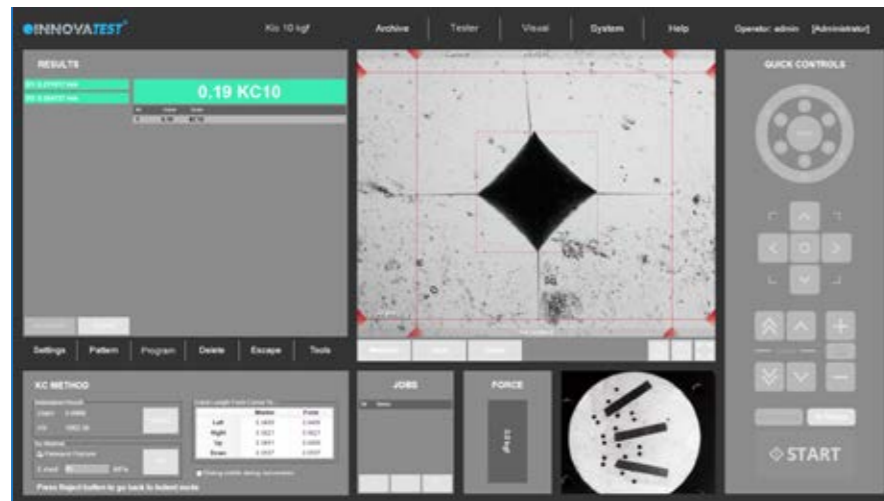

For those requiring more in depth knowledge on materials behavior, wishing to study material fracture and fatigue, crack growth can be predicted and measured by using the Kic application.

The software supports Kic crack detection under load with customized Kic result reporting. By way of one or both methods, Palmqvist or Median / Radial, fracture toughness is now a repeatable and reproducible test across multiple operators.

10 SNAPSHOT FUNCTION

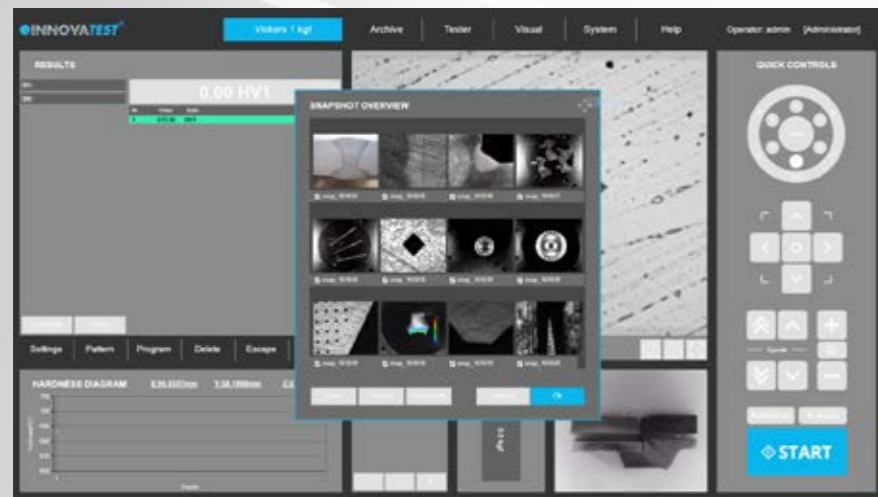

This handy function in IMPRESSIONS™ allows you to make screen captures of the viewing area by way of objective view and/or Overview camera. It gives the opportunity to store such images with comments or to paste them into the report generator for further processing.

11 USER DEFINED PROGRAMS

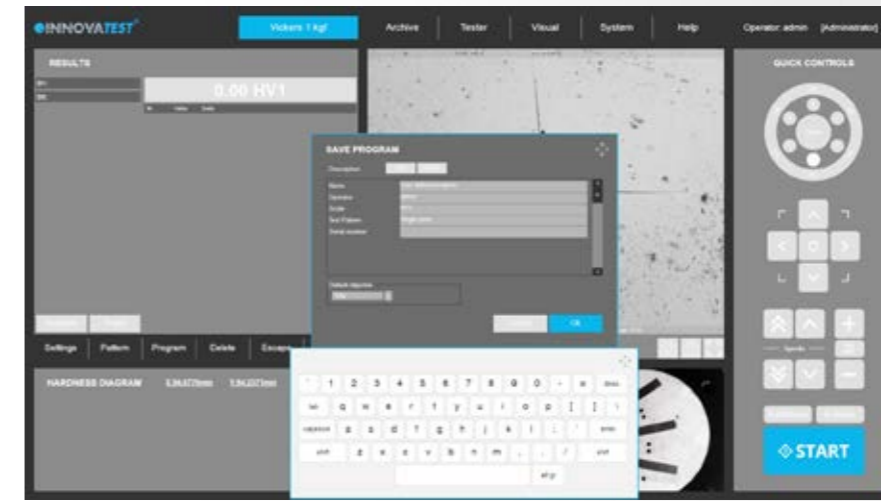

For repeating jobs, IMPRESSIONS™ utilizes the option of setting up and storing custom test programs. For each task, a "job" can be created. All application specific parameters, such as hardness scale, force, dwell-time, pattern, conversion and the report template are stored in the same program.

12 REPORT GENERATOR

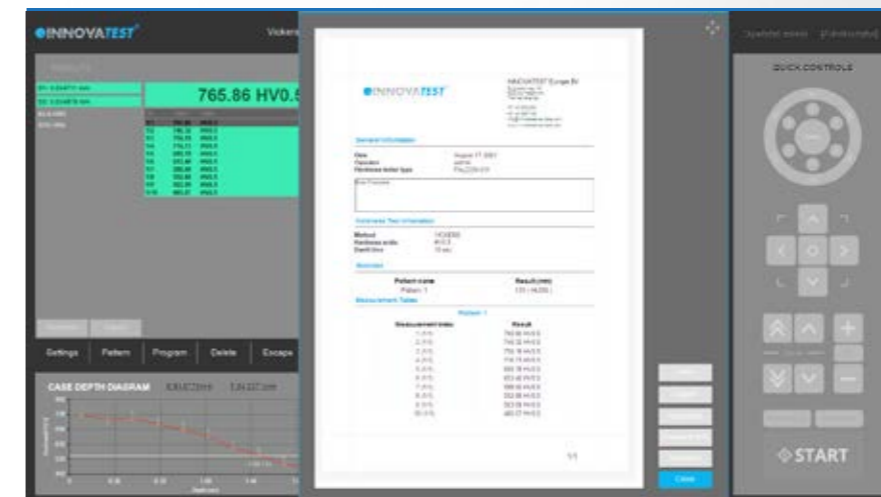

Imagine having a report created for you that includes: Your company name, address, contact information, labeled results related to patterns or sequential, pictures of your optical measurements, stitched images, notes section for each result or pictures, rendition of the pattern performed, overview picture of your pattern on your sample, full statistics, summary of your results, go no-go results, Pass or fail...

All this information or having the ability to only have what you need reported, we call this our Report Configurator. You decide how much or how little you report by PDF or laser printer. We even keep it simple by choosing export to CSV file, to a thumb drive or network file location. Data management at its best!

BARCODE READER

13 BARCODE & QR SOLUTIONS IDENTIFICATION

The basic function of the barcode reader is to load data in to determined user fields.

The BAR | QR code module of INNOVATEST connects the machine to a database or network environment loading samples and data. Whether simply inserting header files (single or serial) or the complete integration of reading devices for the automatic selection of database templates, retrieving data from connected ERP or quality systems (optional) QR and barcode readers simplify complicated work procedures for the operator.



MONITORING

Our world is going through processes influencing our climate and environment. More often we see extreme heat, extreme cold and periods of extreme rain. To assure that such disturbances of nature do not coincidentally effect your measuring or testing results, we have prepared our machines to climate change and forces of nature.

14 VIBRATION & EARTH QUAKE MONITORING



The integrated high precision accelerometer electronics continuously monitor your tester's stability environment. While the tester has vibration isolators (machine dampers) installation environment is often not ideal. Think of heavy traffic, loaded fork lift trucks, excentre presses or other equipment making shop floor installation a base of trouble.

For certain countries/area's in the world where light earthquakes are so common that they are hardly noticed, the vibration monitoring system will give a warning message and stop the hardness testing process to avoid incorrect readings.

15 TEMPERATURE & HUMIDITY MONITORING



Extreme high or low temperatures might not only effect the hardness readings of your machine (think of installation in extremely warm countries or nearby furnaces) extreme humidity might even damage the sensitive electronics.

VIBRATION DAMPENING SOLUTIONS

Most hardness testers in the world stand on 4 or 3 adjustable machine feet. The feet are equipped with a thin layer of rubber which is called vibration damping. In practice that actual means very little as the rubber can only damp very limited vibrations. (see **OPTION 1**). The feet are adjustable and need to be corrected in height if the underground is not perfectly flat.

In such case that the hardness tester can do very low force testing, lets say anything below 100gf, it is always recommended to install the tester on an vibration damping platform.

For the FALCON 800 we have two options, standard **OPTION 1**, which is basically described as above, or the **OPTION 2** which is self-leveling high performance passive vibration damping system, now built under your tester as a standard feature.

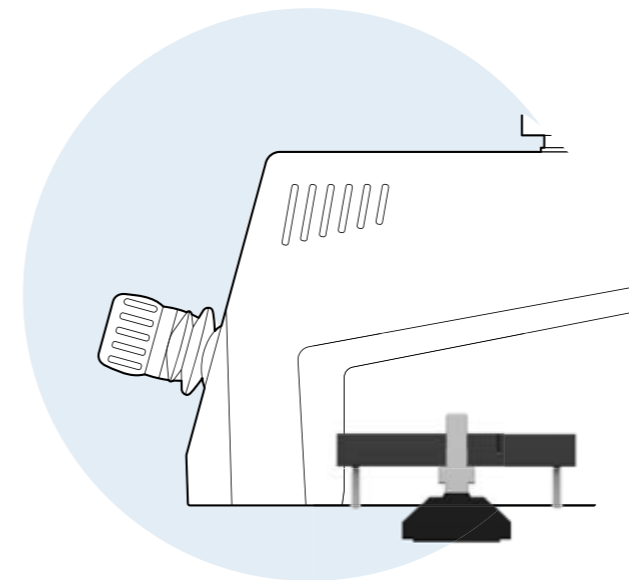

OPTION 1

Adjustable machine dampers sufficient for installing the tester in a solid environment, eliminated from medium frequency vibrations such as high buildings, machine workshops, presses etc. where low force testing is unusual and where there is no heavy traffic (like fork lift trucks) nearby.

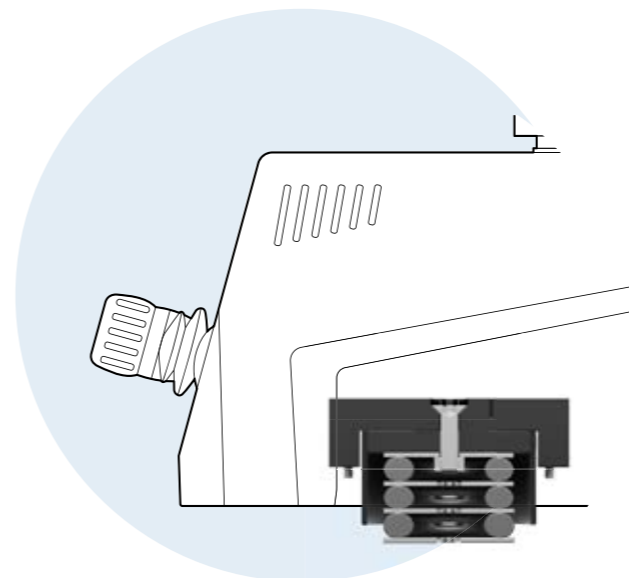

OPTION 2

Sophisticated self-leveling high performance low and high frequency damping system. The multi-layer built-up provides isolation from a broad frequency range most common in the industrial field. It assures that tests forces below 100gf even to the level of 0,1gf can be applied without worrying that vibration might influence the low force indentation process in a negative way.

Also think of certain geographic territories where earthquakes are nearly as common as sunlight.

AUTOMATIC IMAGE EVALUATION



AUTO FOCUS

Fast & precise, observe how IMPRESSIONS™ finds focus from a large distance, as far as the travel of the Z-axis allows. Algorithms used for close distance autofocusing set new standards in AF speed.



AUTOMATIC MEASUREMENT

Manual positioning of filar lines is no longer required. IMPRESSIONS™ refined measurement algorithms detect indents even on very poor or scratched surfaces and measure the relevant indent dimensions according to standards. Stay in control by switching to manual measure mode and have the option of adjusting measurements by touching the screen or using the mouse. Filar lines can be colored to give the best contrast against the specimen's surface. To assure that measurements meet relevant standards on symmetry, enable the automatic indent check. All hardness values can be converted to other scales according to ISO 18265, ASTM E140.

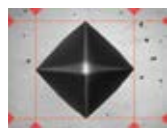

ILLUMINATION SETTINGS

IMPRESSIONS™ software automatic illumination system adapts to the correct illumination regardless of the sample surface quality, wherever on the sample, independent from material (steel, carbide, coated or ceramic). Contrast, Brightness and program, can be set automatically for each measurement or controlled manually. Sharpness can be stored with the pre-determined test.

Complex, refined algorithms ensure reproducible measurements on different materials and even on scratched and damaged surfaces.

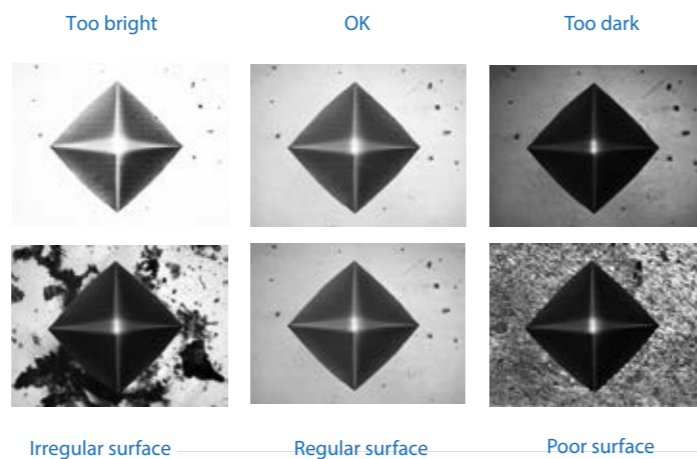

MOTORIZED DIAPHRAGM / IRIS

FALCON 800 optics can be equipped with a CNC motorized diaphragm / iris in the optical system. It expands and contracts to control the amount of light that can pass through. This affects both the brightness of the image and its depth of field.



MOTORIZED LINEAR POLARIZER

FALCON 800 optics can have a linear CNC motorized polarizer (and analyzer) installed. This device converts the beam of the light source, which is unpolarized or mixed-polarization, into a beam with a single polarization state..

SUPERIOR ARTIFICIAL INTELLIGENCE (AI) STANDARD

We include an advanced physics development breakthrough in the image analyses of our Brinell capable hardness testing machines.

The conventional image processing methods on hardness testing machines are fairly successful for clean images that present clear indentation boundaries. In practice, however, workpieces or samples often have rough surfaces that compromise the quality of the image processing which could potentially result in incorrect hardness values.

A human observer can easily find the indentation in both images and the exact boundaries of such indentation (see fig. 1). For a computer algorithm, finding the indentation in the right image is much more challenging due to the many gradients in this image (see fig. 2). Artificial intelligence can overcome this difficulty by training a complex computer neural network to "think" as a human observer.

The INNOVATEST Brinell AI model is trained in our research facility/R&D department using powerful supercomputers. The training phase optimizes millions and millions of weight factors in a neural network, to learn how an indent can look like, using a gradient descent approach. Weight factors have been optimized by a human observer and after optimum weigh factors where determined. Using the AI function on our hardness tester to detect new indentations is called "inference" and requires significantly less computing power. The AI model has been created.

The integrated Intel® Core™ i7 processor can easily handle this task which makes it possible to install and use the INNOVATEST Brinell AI module on the FALCON 800G2 as well.

During inference, a new image (a new Brinell indent image) is entered in to the neural network with weights that where determined during training (see fig. 3).

The complex algorithm is capable to calculate a "mask" on its own, this mask is plotted on top of the indent image, exactly filling the indent and marking the edges that then can be easily detected by automatic image recognition system (see fig. 4).

This super advanced technology requires no special objectives and provides even indents with poor visibility, often the case with shallow indents in rough surface materials, to be perfectly detected and measured.

The system is far superior to special objectives and standard Brinell measuring systems.

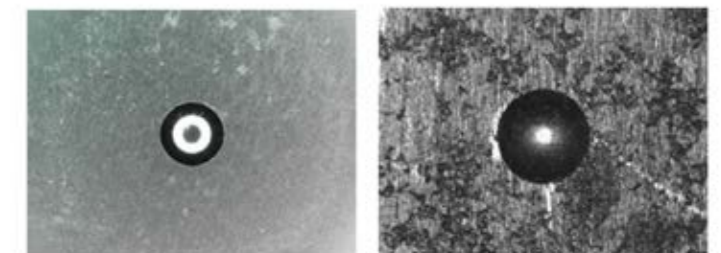

fig.1-2

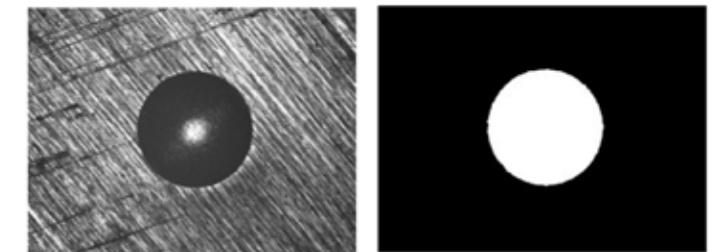

fig.3-4



METALLOSCOPE™

METALLOGRAPHY

SOFTWARE

The objectives on the FALCON 800G2 make the hardness tester into an excellent highly automated metallographic microscope. Metallographic studies are of key importance in the manufacturing process of metals and steel, in the aerospace and automotive industry, in mechanical engineering, construction and in the manufacturing of a vast number of industrial and consumer products.

Microscopy is an indispensable feature of every metallographic lab, whether you investigate damages, develop novel alloy materials or perform quality control to ensure the purity of steel. The measurement of certain parameters such as volume fraction, coating thickness and grain size is specified in strict standards and norms.

Metallography is used to investigate metals from copper and titanium to iron, steel and alloys of every description. These investigations can now be performed quantitatively and reliably using the INNOVATEST Metalloscope™ 1 software module, running on most of our higher-end hardness testing machines.

The microstructure of metals has a significant influence on properties such as strength and corrosion resistance. Therefore, a detailed investigation of the microstructure with the help of microscopy is central to metallographical disciplines as well as many industrial applications.

GRAIN SIZE | DIN EN ISO 643 & ASTM E112



Grain size:
The grain size index can be calculated in various 1 or 2 dimensional way; using a 1-dimensional method (from the number of grain intercepts per mm) or a 2-dimensional method (from the number of grains per mm²). Line profile: 1-dimensional grain size index calculation by counting the number of grain intercepts on a line. Hexagonal grid: 2-dimensional grain size index calculation using a superimposed hexagonal grid or single grains calculation by counting the number of grains in a specific part of the image (blue box).

Hardness tester and metallurgical microscope.

Basic metals undergo specific treatment in order to prepare them for particular applications and to improve their characteristics, for example by adding alloying elements. In many cases, the microscopy investigation focusses on the correlation between the resulting microstructure and the material properties.

VOLUME FRACTION | ISO 9042 & ASTM E562

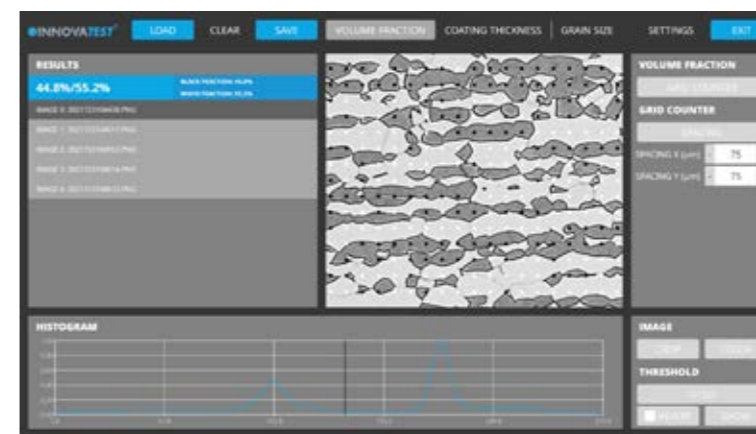

Volume fraction:
Various methods integrated; the example shows a sample consisting of ferrite (black material) and austenite (white material). Pixel counter: calculation based on histogram-guided image thresholding. Two automatic thresholding algorithms in addition to manual thresholding. Grid counter calculation using a superimposed grid. Each grid point can be assigned to the black material or white material. Initial values (black or white) are assigned automatically, but can be toggled manually. Grid positions are calculated by defining the number of grid points or the grid spacing.

COATING THICKNESS | DIN EN ISO 1463

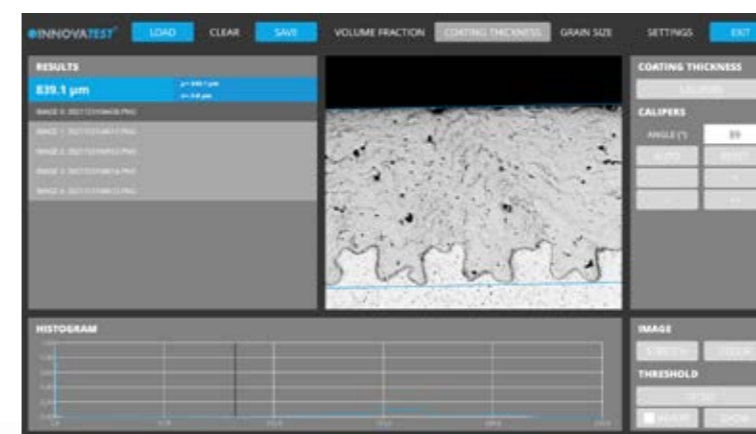

Coating thickness:
Calculate the thickness of a coating layer. This can be a single thickness or a mean thickness with standard deviation or a coating contour. Calculation using two parallel lines. The resulting coating thickness is the distance between these lines. Calipers can be rotated, automatic or manual. Coating contour: coating thickness calculation based on a number of measurement points. Contour edges are drawn semi-automatically and the number of measurement points can be selected by the user.

The FALCON 800G2 is basically an upright, brightfield and darkfield microscope. Contrast methods of reflected light brightfield result are best suited to analyze the microstructures of etched surfaces. Recognizing grain boundaries, you can draw conclusions on grain sizes, phases and structural constituents. Impurities and structural constituents, such as graphite in cast iron, prior to etching are getting visible.

Reflected light darkfield shows up mechanical surface faults such as fracture sites, pores and inclusions as well as cracks, scratches and cavities. In combination with the FALCON 800G2 automation, the system provides in maximum efficiency for both hardness testing and materials inspection.



STEP 1: Select machine type



STEP 2: Additional force range

- OPTION 2 10gf - 2kgf
- OPTION 3 10gf - 10kgf
- OPTION 4 10gf - 31.25kgf
- OPTION 5 10gf - 62.5kgf
- OPTION 6 200gf - 62.5kgf

- EXTENSION A 0.1gf - 1gf
- EXTENSION B 1gf - 10gf
- EXTENSION C 10gf - 200gf
- EXTENSION D 2kgf - 10kgf
- EXTENSION E 10kgf - 31.25kgf
- EXTENSION F 31.25kgf - 62.5kgf

STEP 3: Dampening systems



STEP 4: Indenters

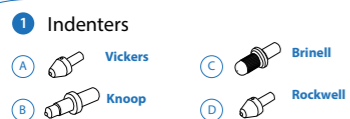

STEP 5: Optical

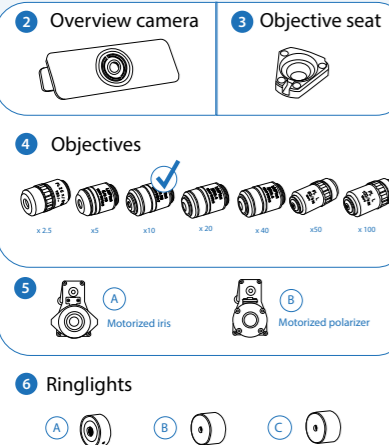

STEP 6: Tables/Enclumes

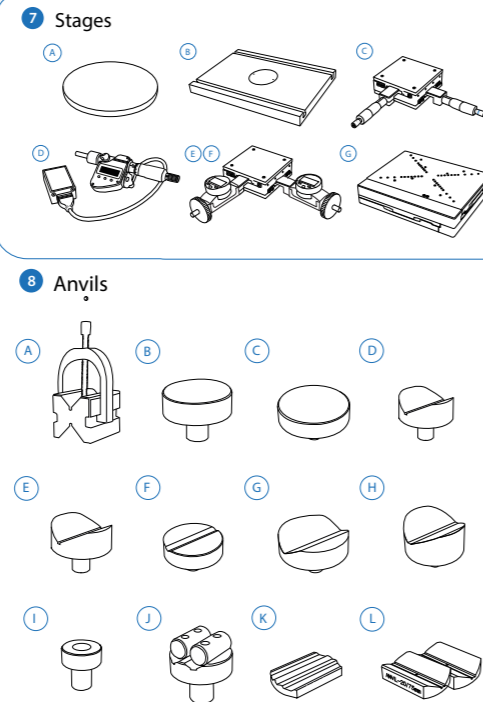

STEP 7: Sample holders

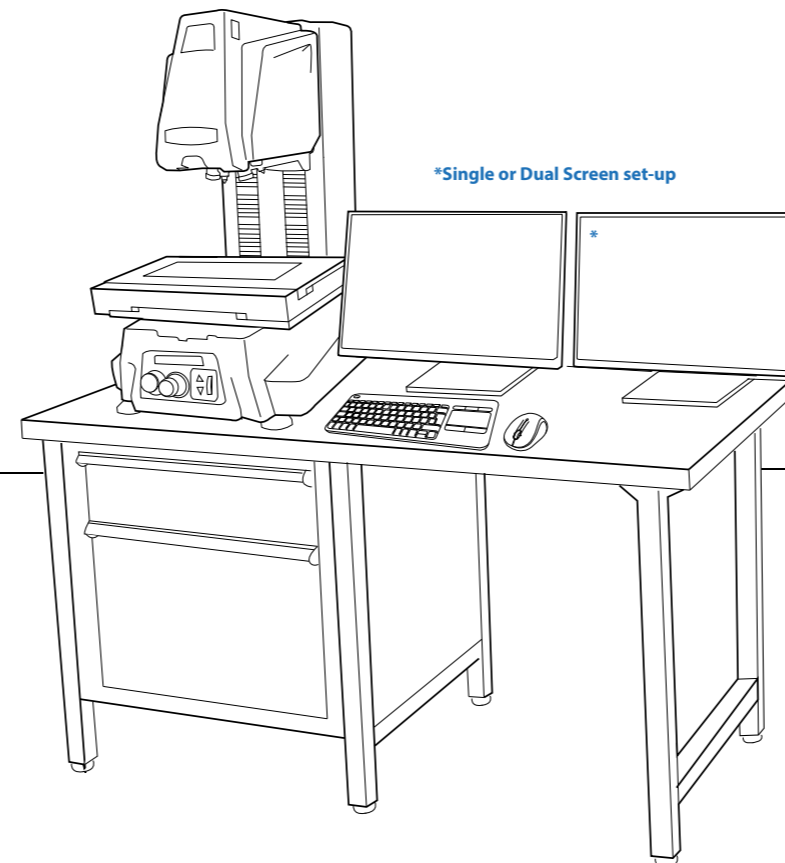
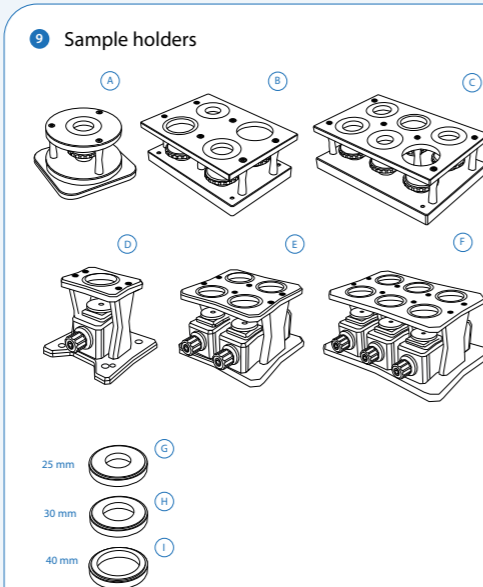

STEP 9: Software

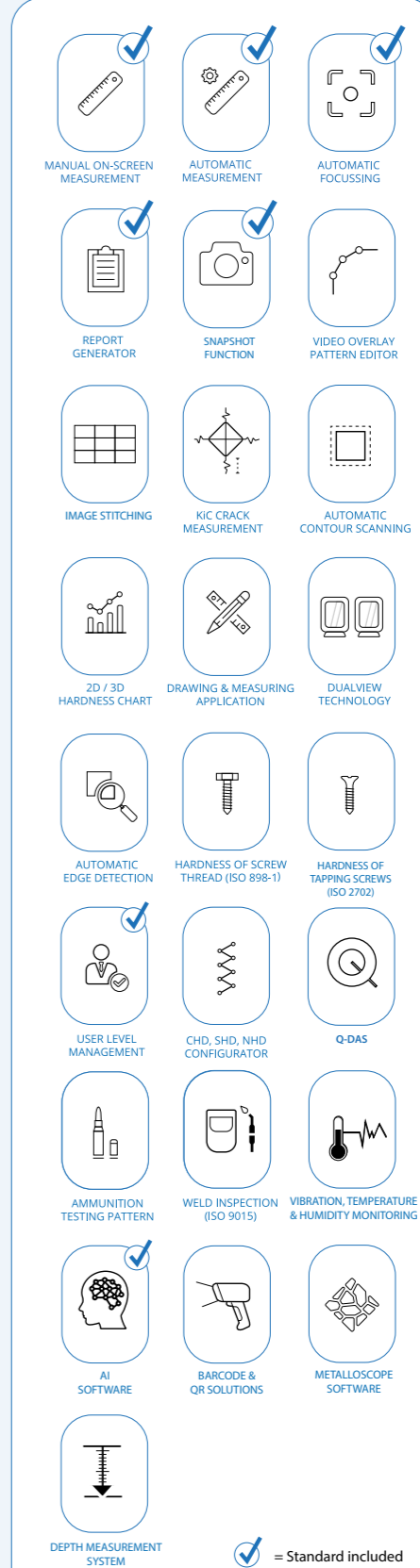

✓ = Standard included

ORDER DETAILS

FALCON 800G2



FALCON 800A Micro hardness tester, version A, motorized descending test-head	FALCON 800A	
FALCON 800B Micro hardness tester, version B, motorized ball screw Z-axis	FALCON 800B	
FALCON 800C Micro hardness tester, version C, motorized descending test-head, motorized balls screw Z-axis	FALCON 800C	
OPTION 1: Force range fixed 5gf - 2kgf, (can not be extended)	N/A	
OPTION 2: Force range 10gf - 2kgf	SLFRG2O2	
OPTION 3: Force range 10gf - 10kgf	SLFRG2O3	
OPTION 4: Force range 10gf - 31.25kgf	SLFRG2O4	
OPTION 5: Force range 10gf- 62.5kfg	SLFRG2O5	
OPTION 6: Force range 200gf- 62.5kfg	SLFRG2O6	
Extension A: Force range extension 0.1gf - 1gf (requires extension B)	SLFRG2A	
Extension B: Force range extension 1gf - 10gf	SLFRG2B	
Extension C: Force range extension 10gf - 200gf	SLFRG2C	
Extension D: Force range extension 2kgf - 10kgf	SLFRG2D	
Extension E: Force range extension 10kgf - 31.25kgf	SLFRG2E	
Extension F: Force range extension 31.25kgf - 62.5kgf	SLFRG2F	
Indenter actuator post (2nd indenter position) factory installed	SA-02-0129	
Plug & Play prepared, calibration, sea & airworthy packing in "non coniferous wood" material	P&PSEAPACK44	

ACCESSORIES

STEP 3	Dampening systems	OPTION 1: Adjustable machine dampers	ASSUN-M10 FOOT	STANDARD
		OPTION 2: Self-leveling low and high frequency machine dampers	SA-08-0023	
STEP 4	Indenters			
1	Vickers	A Micro Vickers Indenter Ø3mm ISO/ASTM certified	UPI/8105	STANDARD
	Knoop	B Micro Knoop Indenter Ø3mm ISO/ASTM certified	UPI/8205	
	Brinell	C Brinell Indenter 1mm. Includes 1 carbide ball. Ø3mm. ISO & ASTM certified	UPI/7001	
		Brinell Indenter 2.5mm. Includes 1 carbide ball. Ø3mm. ISO & ASTM certified	UPI/7006	
		Brinell Indenter 5mm. Includes 1 carbide ball. Ø3mm. ISO & ASTM certified	UPI/7011	
	Rockwell	D Rockwell C Diamond Indenter. Ø3mm. ISO & ASTM certified	UPI/6003	
		Rockwell Ball Indenter 1/16". Includes 1 carbide ball. Ø3mm. ISO & ASTM certified	UPI/7503	
		Rockwell Ball Indenter 1/8". Includes 1 carbide ball. Ø3mm. ISO & ASTM certified	UPI/7603	
		Rockwell Ball Indenter 1/4". Includes 1 carbide ball. Ø3mm. ISO & ASTM certified	UPI/7703	
STEP 5	Optical			
2	Overview Camera	HD Overview camera. Full view zoom camera + software functionality	SA-05-0053	
3	Objective seat	Objective seat assembly	SA-05-0030	
4	Objectives	2.5x Objective - Infinite	BM-05-0029	
		5x Objective - Infinite	BM-05-0030	STANDARD
		10x Objective - Infinite	BM-05-0034	
		20x Objective - Infinite	BM-05-0031	
		40x Objective - Infinite	BM-05-0035	
		50x Objective - Infinite	BM-05-0032	

		100x Objective - Infinite	BM-05-0033	
5	Motorized diaphragm/iris	Motorized diaphragm/iris	SA-05-0054	
	Motorized polarizer	Motorized polarizer	SA-05-0040	
6	Ring lights	A 2.5x Infinite objective ringlight assembly	SA-05-0043	
		B 5x Infinite objective ringlight assembly	SA-05-0044	
		C 10x Infinite objective ringlight assembly	SA-05-0045	
STEP 6	Stages/Anvils			
7	Stages	A Testing table flat ø200mm, screwfix	UN-TESTTABLE/010	
		Testing table flat ø235mm, screwfix	UN-TESTTABLE/012	
		B Large flat surface testing table 350x250mm, thickness 30mm with 2 T-slots, for large components	UN-TESTTABLE/015	
		Quick change anvil base (required for mounting testing tables, anvils)	AS5000-450	
		C Manual X-Y stage with analogue metric micrometers, 100x100mm Displacement: 25x25mm, scale 0.01mm, max load 60kg	UN-XYSTAGE/115	
		Manual X-Y stage with analogue metric micrometers, 100x100mm Displacement: 25x25mm, scale 0.01mm, max load 100kg	UN-XYSTAGE/120	
		D Digital micrometer, for manual X-Y stage, Displacement: 25mm, resolution 0.001mm	IMP-DIGMIC	
		E Manual iSMART™ stage, 150x150mm, Displacement: 50x50mm	BM-08-0057	
		F Digital control unit for Manual iSMART™ stage, 25mm travel	BM-08-0058	
		Digital control unit for Manual iSMART™ stage, 50mm travel	BM-08-0059	
		G iSMART™ motorized CNC X-Y stage, 215x160mm, total load up to 400Kgf max. Displacement: 75x75mm, resolution 0.001mm, repeatability +/-0.0015mm	MA-XY7575S	
		iSMART™ stage, 260x205mm, total load up to 400Kgf max. Displacement: 120x120mm, resolution 0.001mm, repeatability +/-0.0015mm	MA-XY1212S	
		iSMART™ stage, 360x205mm, total load up to 400Kgf max. Displacement: 220x120mm, resolution 0.001mm, repeatability +/-0.0015mm	MA-XY2212S	
		iSMART™ stage, 490x224mm, total load up to 400Kgf max. Displacement: 340x120mm, resolution 0.001mm, repeatability +/-0.0015mm	MA-XY3412S	
	<i>Cable sets, mounting & Connectivity for motorized stage</i>	iSMART™ quick connect foot	SA-08-0024	
8	Anvils	A V block with bracket 40x40x50mm (LxBxH)	UN-VBLOCK404050	
		B Flat anvil 60mm	AS3000-19-04	
		C Flat anvil 80mm	UN-TESTTABLE/002	
		D V-anvil ø40mm 6-60mm	UN-ANVIL/005	
		E V-anvil ø63mm 6-60mm	UN-ANVIL/006	
		F V-Anvil ø80mm 3.3-20mm	UN-ANVIL/040	
		G V-Anvil ø80mm 12-80mm	UN-ANVIL/045	
		H V-Anvil ø80mm 23-140mm	UN-ANVIL/050	
		I Anvil for spherical specimen dia. 6-25,4mm	UN-ANVIL/200	

		J	Cylindrical V anvil 6-80mm	UN-CVANVIL680	
			Cylindrical V anvil 50-200mm	UN-CVANVIL50200	
			Test table 100x100mm, V groove 20mm wide, 10mm deep	UN-TESTTABLE/040	
		K	Small V-Anvil 3-20mm requires base plate (Requires Manual/Autom. X-Y stage)	UN-ANVILSV/105	
		L	Large V-Anvil 20-75mm requires base plate (Requires Manual/Autom. X-Y stage)	UN-ANVILLV/106	
			Base plate for V-anvils un-anvilsv/105 & 106	UN-VANVILBASEPL	
STEP 7	Sample holders				
9	Sample holders	A	1 position sample holder, for 1 embedded sample, diameter 50mm or 2"	UN-ESH1	
		B	4 position sample holder, for max. 4 embedded samples, diameter 50mm or 2"	UN-ESH4	
		C	6 position sample holder, for max. 6 embedded samples, diameter 50mm or 2"	UN-ESH6	
		D	1 position sample holder, for 1 embedded sample, diameter 50mm or 2" with front operation elevator knob	BM-08-0052	
		E	4 position sample holder, for max. 4 embedded samples, diameter 50mm or 2" with front operation elevator knob	BM-08-0053	
		F	6 position sample holder, for max. 6 embedded samples, diameter 50mm or 2" with front operation elevator knob	BM-08-0054	
		G	1 insert reduction ring 25mm	UN-ESHI25	
		H	1 insert reduction ring 30mm	UN-ESHI30	
		I	1 insert reduction ring 40mm	UN-ESHI40	
			1 insert reduction ring 1"	UN-ESHI1	
			1 insert reduction ring 1 1/4"	UN-ESHI125	
			1 insert reduction ring 1,5"	UN-ESHI15	
STEP 8	Fixtures & vices				
10	Fixtures & vices	A	Polished precision vice with lock down system, jaw width 25mm, opens 20mm	UN-VICE/210	
		B	Polished precision vice with lock down system, jaw width 36mm, opens 42mm	UN-VICE/215	
		C	Polished precision vice with lock down system, jaw width 48mm, opens 75mm	UN-VICE/220	
		D	Polished precision vice with lock down system, jaw width 75mm, opens 100mm	UN-VICE/230	
		E	Axle chuck 500 series for cylinder parts, dia. 0.4mm to 5mm	UN-AXLECHUCK	
		F	Universal Clamp & Leveling Device	UN-CLAMP/105	
		G	Thin metal clamp	UN-CLAMP/115	
		H	V groove clamp for small round parts dia.0.8-5mm	UN-VGROOVE-CLAMP	
		I	Wire Testing Fixture for specimen dia. 0.8-3.5mm	UN-WIRE/105	
		J	Small parts vice jaw width 55mm, open 50mm, self centering	UN-VICE/115	
STEP 9	Software				
	Additional Software		Manual on-screen measurement	UN-MANM	STANDARD
			Automatic measurement	UN-AUTOM	STANDARD
			Automatic focussing	UN-AUTOFOC	STANDARD
			Report configurator	UN-REPORTA	STANDARD
			Snapshot function	UN-SNAPSH	STANDARD
			Advanced 3 axis coordinate & free style indent pattern configurator, for motorized stage only	UN-TESTPAT01	
			Advanced 3 axis coordinate & free style indent pattern configurator, + CHD, SHD, NHD and edge detection, (supports manual & digital micrometer stages only)	UN-TESTPAT02	
			Image stitching, composes full stage overview, and detailed sample overview. High resolution magnification of designated test area. Requires a motorized stage.	UN-IMST01	

			KiC crack detection under load. Palmqvist & Median / Radial fracture toughness	UN-CRKPAP	
			Automatic Contour scanning	UN-CSCAN	
			2D / 3D hardness scanning (mapping, includes automatic contour scanning)	UN-CSCAN2D3D	
			Drawing and measuring (distance & angles) application	UN-DRMEAS	
			DualView Technology, 2 viewing screens software, screen, cables, Europe and US power cable included, 27" Industrial LCD screen included	UN-DVTECHSET24	
			Automatic edge detection	UN-EDGEDTC	
			ISO 898-1 screw thread measurement of (de)-carbonized part (requires UN-CSCAN)	UN-ISO898/1	
			ISO-2702 tap screw thread measurement	UN-ISO2702	
			User level management	UN-LEVMAN	STANDARD
			CHD, SHD, NHD configurator & graphic interface for analogue and digital micro meter stage only (not including full pattern editor)	UN-MCHD	
			CHD, SHD, NHD configurator & graphic interface requires: indent pattern configurator (TESTPAT01)	UN-PATCHD	
			Q-DAS Certified connectivity protocol	UN-QDAS	
			Advanced 3-axis communication protocol for robotic systems	UN-REMC	
			ISO bullets casings pattern configurator and reporting system	UN-SHELLCONF	
			ISO 9015 Weld pattern configurator (automatic weld pattern configurator), requires overview camera or AS9000-0.70BJ	UN-WELDPAT	
			Vibration, temperature & humidity monitoring	UN-VIBCLC	
			Artificial Intelligence Deep Learning Brinell module	UN-AIDLB01	STANDARD
			Barcode & QR data mapping software	UN-SCANFLOW	
			Metalloscope™ metallography software pack	UN-MSCPV1	
	Connectivity Plus		Utility software; Import test results in MS applications like Excel	UN-SW/905	
			USB to USB null modem cable 2.5M	BE-99-0025	
			Bluetooth connectivity	UN-BTADAPT	
			Wireless system Keyboard & wireless mouse	UN-SKBSET	STANDARD
			Virtual joystick, on-screen		STANDARD
	Additional items				
	Machine stands		Cabinet test table with drawer for hardness testers 71x75x80cm	UN-STAND/960	
			Cabinet test table with drawer for hardness testers 150x75x80cm	UN-STAND/965	
			Seaworthy packing box for 950/960	PACK/100	
			Seaworthy packing box for 965	PACK/200	
	Printer		Laser Printer	UN-PRINT	
	Projector		On request, any brand of choice	UN-PROJECTOR	
	Machine cover		Machine cover 600x700x770mm	UN-COVER4	
	CE Automation safety cabin		Front access safety cabin with light shield. Machines controls positioned outside cabin. External connectors for screen, keyboard etc.	SA-27-0005	
	ISO 17025 UKAS		UKAS EN ISO 17025 Direct/Indirect calibration report	CCERTFEE/UKAS	
	ISO 17025 UKAS ISO / ASTM Calibration		BRINELL direct and indirect calibration & certification, traceable, in compliance with ISO & ASTM, NADCAP. Flat fee for selected common scales, per scale.	CCERTUKAS/1B	
	ISO 17025 UKAS ISO / ASTM Calibration		VICKERS direct and indirect calibration & certification, traceable, in compliance with ISO & ASTM, NADCAP. Flat fee for selected common scales, per scale.	CCERTUKAS//1V	
	ISO 17025 UKAS ISO / ASTM Calibration		KNOOP direct and indirect calibration & certification, traceable, in compliance with ISO & ASTM, NADCAP. Flat fee for selected common scales, per scale.	CCERTUKAS/1K	
	ISO 17025 UKAS ISO / ASTM Calibration		ROCKWELL direct and indirect verification/calibration & certification in compliance with ISO & ASTM, NADCAP, flat fee for selected common scales, per scale.	CCERTUKAS/1R	

ACCESSORIES

INDENTERS



OPTICAL



STAGES/ANVILS

Anvils



SAMPLE HOLDERS

Sample holders - Regular model

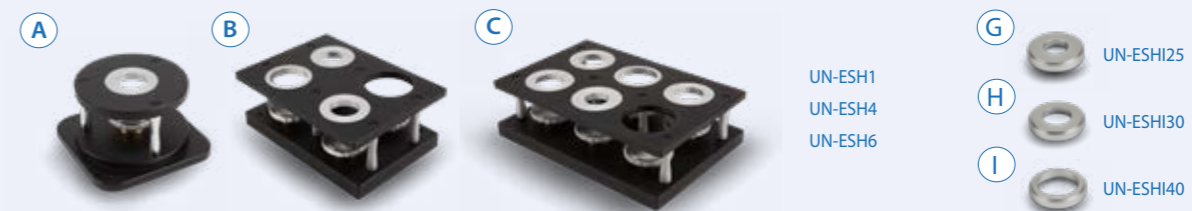

Sample holders - Front operation



STAGES/ANVILS

Stages



Anvils



FIXTURES & VICES

Fixtures & vices



CE Automation safety cabin



SPECIFICATIONS

HARDNESS SCALES

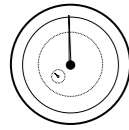
	VICKERS ISO 6507 ASTM E384, E92 JIS B 7725 *Extended range	HV0.001 HV0.002 HV0.003 HV0.004 HV0.005 HV0.006 HV0.007 HV0.008 HV0.009 HV0.010 HV0.015 HV0.020 HV0.025 HV0.050 HV0.1 HV0.2 HV0.3 HV0.5 HV1 HV2 HV2.5 HV3 HV4 HV5 HV10 HV20 HV25 HV30 HV40 HV50 HV60 *(HV0.0001 - HV0.0009 increases with steps of HV 0.00005)
	K_{IC} Fracture toughness	All Vickers forces & scales
	KNOOP ISO 4545 ASTM E92 JIS Z 2251	HK0.001 HK0.002 HK0.003 HK0.004 HK0.005 HK0.006 HK0.007 HK0.008 HK0.009 HK0.010 HK0.015 HK0.020 HK0.025 HK0.050 HK0.1 HK0.2 HK0.3 HK0.5 HK1 HK2 HK5
	BRINELL ISO 6506, ASTM E10 JIS Z 2243	HBW1/1 HBW1/1.25 HBW1/2.5 HBW1/5 HB1/10 HBW1/30 HBW1/31.25 HBW2.5/6.25 HBW2.5/7.8125 HBW2.5/15.625 HBW2.5/31.25 HBW2.5/62.5 HBW5/25 HBW5/31.25 HBW5/62.5
	ROCKWELL (OPTIONAL) Requires Depth measuring system EN-ISO 6508 ASTM E-18 JIS Z 2245	Regular Rockwell scales; Pre Load 10kgf, Main Load 60kgf A F H L Superficial Rockwell scales; Pre Load 3kgf, Main Load 15kgf 30kgf 45kgf 15N 30N 45N 15T 30T 45T 15W 30W 45W 15X 30X 45X
	HVD (HVT) (OPTIONAL) VDI/VDE 2616-1	HV5 HV10 HV20 HV25 HV30 HV40 HV50 HV60
	HBD (HBT) (OPTIONAL) VDI/VDE 2616-1	HBW1/5 HBW1/10 HBW1/30 HBW2.5/6.25 HBW2.5/7.8125 HBW2.5/15.625 HBW2.5/31.25 HBW2.5/62.5
	CARBON (OPTIONAL)	HR 2.5/7 HR 5/7 HR 5/15 HR 5/20 HR 5/40 HR 5/60
	CONVERSIONS	Conversion to other hardness scales according to ASTM E140, ISO 18265, GB/T 1172
	METALLURGY	Grain size DIN EN ISO 643, ASTM E112 Volume fraction ISO 942, ASTM E562 Coating thickness DIN EN ISO 1463

TEST FORCE

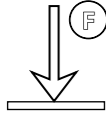
	Force application	Multi-load cell, closed loop, force feedback system
	Test forces	0.1gf – 62.5kgf
	Dwell time settings	Default 10 seconds, user defined. Up to 999 seconds
	Force range per model	FALCON 800G2A 0.1gf - 62.5kfg FALCON 800G2B 0.1gf - 62.5kfg FALCON 800G2C 0.1gf - 62.5kfg
	Test force tolerance	< 0.25% for test force 100gf to 62.5kgf < 0.5% for test force below 100gf

TURRET

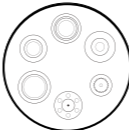
	Motorized turret	Ultra-fast, 8 position turret, 2 indenter positions, 4 objective positions, touch probe, laser
	Objectives	Long working distance 2.5x, 5x, 10x, 20x, 40x, 50x, 100x
	Indenters	Certified indenters (ISO/ASTM) available at choice
	Camera 1 (objective)	18 Mpx Full HD, HD, 4K+, Machine vision system
	Camera 2 (overview)	18 Mpx Full HD, variable FOV 66 x 50 - 200 x 150mm

SYSTEM

	Electronic system Standard (Recommended)	High performance embedded controller, i7, mSSD 120 GBxx, MS Windows® 10 operated, up to 8 years* INNOVATEST warranty
	Electronic system (Optional)	High performance external controller, i7 or i9, mSSD 120 GBxx, MS Windows® 10 operated, 1 year factory warranty
	CNC support	CNC controller (for motorized stages) or stage accessories
	Screen(s)	27" portrait mode capacitive touch screen, second screen option
	Display resolution	0.01 HV, HK, HB
	Statistics	Total test, max, min, average, range, standard deviation, All in real time after each test
	Hardness conversion	Rockwell, Rockwell Superficial, Vickers, Brinell, Knoop, Leeb & Tensile
	Software	IMPRESSIONS™ V4, work flow system & tester control
	Data storage capacity	Internal and external mSSD, SSD or HDD
	Data output	XML, CSV, Certified for Q-DAS (optional)
	Connectivity	5 USB ports, RJ45 Ethernet LAN, W-LAN, RS-232, Blue Tooth, 5 Axis CNC & motorized X-Y stage connector, Dual HDMI screen connectors
	Printer	A4, A3 full color laser printer (optional)

GENERAL

	Machine dimensions	784mm (H) x 490mm (W) x 645mm (D)
	Workpiece accommodation	243mm (H) x 180mm (D)
	Machine weight	157 kg
	Power supply	100VAC to 240VAC, 50/60Hz, single phase
	Operating temperature	10°C to 35°C
	Power consumption	100W
	Humidity	10% to 90%, non-condensing
	Noise	< 70 db(A)

* Check individual warranty conditions

TECHNICAL DRAWINGS

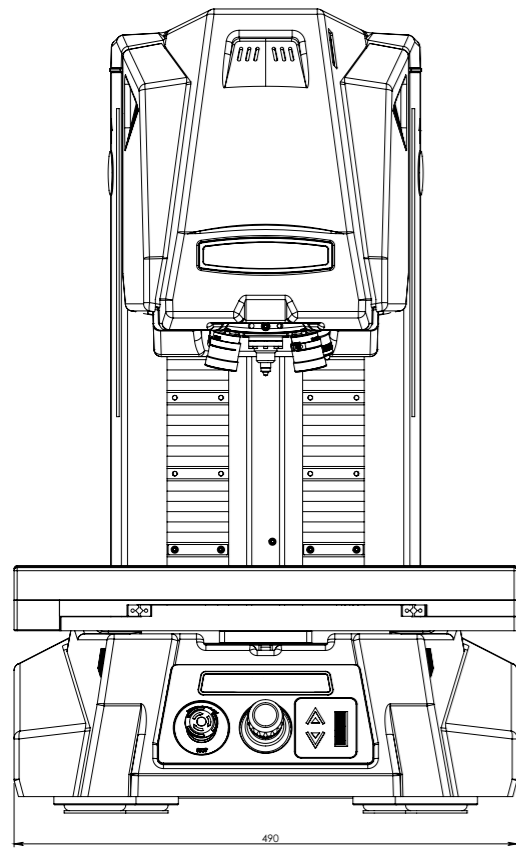

All dimensions in these drawings are in mm, approximate. Working heights and or workpiece accommodation varies depending on the stages and stage accessories used.

Please contact our sales department for more details.

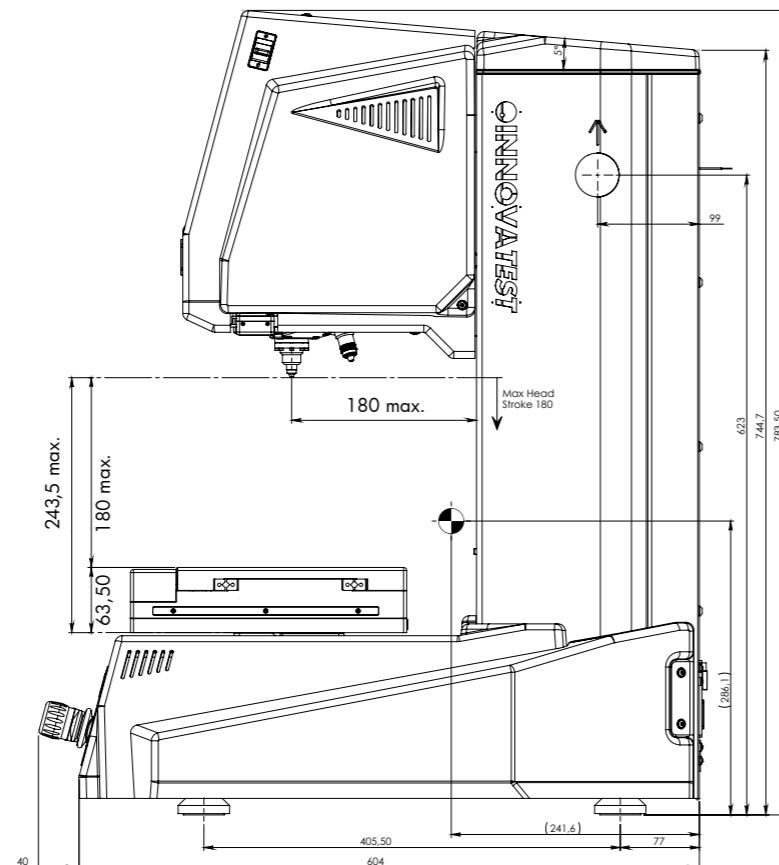
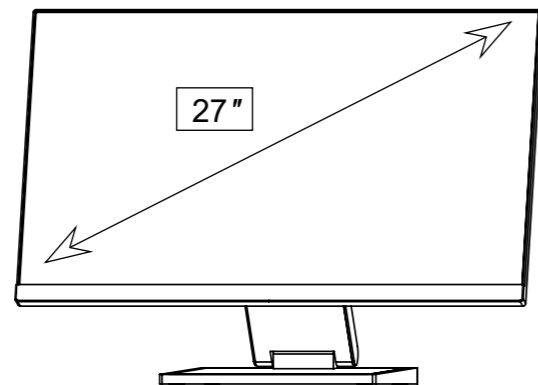

OTHER MODELS IN THE FALCON RANGE



FALCON 400G2

Load Cell, Closed loop
Micro/Macro Vickers, Knoop
& Brinell Hardness testers
With fine adjustable Z-axis
side handwheel
See brochure B22F400G2/XX



FALCON 450G2

Load Cell, Closed loop
Macro/Micro Vickers, Knoop
& Brinell Hardness tester
With Z-axis handwheel
See brochure B22F450G2/XX



FALCON 500G2

Multi Load Cell, Closed loop
Fully automatic, free to
configure Micro/Macro Vickers,
Knoop & Brinell Hardness
testers. With ball bearing
motorized Z-axis
See brochure B22F500G2/XX



FALCON 600G2

Multi Load Cell, closed loop
Fully automatic, free to
configure Micro/Macro Vickers,
Knoop & Brinell Hardness
testers. With ball screw
motorized Z-axis
See brochure B22F600G2/XX



FALCON 5000G2

Multi Load Cell, closed loop
Fully automatic, 8 position
turret, laser positioning.
Micro/Macro Vickers, Knoop
& Brinell Hardness testers.
Descending test head,
fixed work piece position
See brochure B22F5000G2/XX

Changes in products and/or product specifications can emerge due to new technologies and continuous development.

We reserve the right to change or modify specifications of the products without prior notice. We recommend you to contact our sales office for up-to-date information.

Brochure B22F800G2/06/EN

EUROPE

INNOVATEST Deutschland GmbH.
Sales & Service
Phone: +49 245 670 59 500
info@innovatest-deutschland.com
www.innovatest-deutschland.com

INNOVATEST France SARL
Sales & Service
Phone: +33 1 848 88038
commercial@innovatest-france.com
www.innovatest-france.com

INNOVATEST UK Ltd.
Sales & Service
Phone: +44 (0) 121 824 4775
info@innovatest-uk.com
www.innovatest-uk.com

INNOVATEST Polska sp. z o.o
Sales & Service
Phone: +48 697 099 826
info@innovatest-polska.pl
www.innovatest-poland.com

MIDDLE EAST

INNOVATEST Middle East LLC
Sales & Service
Phone: +971- 4- 880 0875
info@innovatest-mideast.com
www.innovatest-mideast.com

NORTH-AMERICA

INNOVATEST USA Inc.
Sales & Service
Phone: +1 267 317 4300
info@innovatest-usa.com
www.innovatest-usa.com

ASIA

INNOVATEST Shanghai Co., Ltd.
Sales & Service
Phone: +86 21 60906200
Fax: +86 21 60912595
info@innovatest-shanghai.com
www.innovatest-shanghai.com

INNOVATEST Japan Co., Ltd.
Sales & Service
Phone: +81 3 3527 3092
Fax: +81 3 3527 3093
info@innovatest-japan.com
www.innovatest-japan.com

INNOVATEST South East Asia
Sales & Service
Phone: +65 6451 1123
Fax: +65 6452 1011
info@innovatest-singapore.com
www.innovatest-singapore.com

Distributor :

CORPORATE HEAD OFFICE

INNOVATEST Europe BV
Manufacturing, Distribution & Service
Borgharenweg 140
6222 AA MAASTRICHT
The Netherlands

Phone: +31 43 3520060
Fax: +31 43 3631168
info@innovatest-europe.com
www.innovatest-europe.com